

# Simulation and Experimental Results of a 3 kWp Rooftop PV System in Surabaya

Fitri Dwi Kartikasari<sup>1,2</sup>, Elieser Tarigan<sup>2,3</sup>, Alejandro Comte Torres<sup>2</sup>

<sup>1</sup>Department of Informatics Engineering, University of Surabaya

<sup>2</sup>Center for Renewable Energy Studies (PSET), University of Surabaya

<sup>3</sup>Department of Electrical Engineering, University of Surabaya

Raya Kalirungkut, Surabaya, 60293, Indonesia

fitri\_dk@staff.ubaya.ac.id

---

---

## Abstract

Simulation studies for a PV system would be useful for planning before real implementation, and to predict the cost for a large scale PV system. This work is to simulate a 3 kWp rooftop photovoltaic (PV) system under the climate of Surabaya, Indonesia. SolarGIS PV Planner and RETScreen simulation tools are used in this work. The simulation results are then compared with a full year of measurement results. The results of simulations show that a 3 kWp rooftop system could produce electricity of 4,200 kWh per year, while in the real measurement energy production is found about 3,898 kWh per year. There were slightly different results values of energy output between Simulation and real measurement of the PV system, however statistically it still can be accepted. Economic analysis shows that, under current conditions, a grid-connected PV system investment would give about 5 years of the payback period. Environmentally, the 3 kWp PV system would provide a reduction of CO<sub>2</sub> emission of about 2.7 tons per year.

**Keywords:** simulation, experimental, rooftop PV system, Surabaya

## Abstrak

*Kajian hasil simulasi suatu system Pembangkit Listrik Tenaga Surya (PLTS) sangat bermanfaat untuk membantu proses perencanaan sebelum diimplementasikan, terutama untuk memperkirakan biaya pembangunan PLTS skala besar. Dalam penelitian ini dilakukan simulasi suatu system PLTS atap kapasitas 3 kWp dengan asumsi kondisi iklim kota Surabaya, Indonesia. Perangkat yang digunakan untuk simulasi adalah SolarGIS PV Planner dan RETScreen. Selanjutnya hasil simulasi dibandingkan dengan data pengukuran yang telah diperoleh selama satu tahun. Hasil simulasi menunjukkan bahwa system PLTS atap berkapasitas 3 kWp dapat menghasilkan listrik sebesar 4.200 kWh per tahun, sementara data pengukuran menunjukkan produksi listrik hanya sebesar 3.898 kWh per tahun. Terdapat sedikit perbedaan rata-rata produksi listrik tiap bulan antara simulasi dan pengukuran langsung, namun secara statistik perbedaan tersebut tidak signifikan. Analisis secara ekonomi menunjukkan bahwa investasi sistem PLTS yang terhubung dengan PLN akan kembali dalam kurun waktu sekitar 5 tahun. Pemasangan PLTS dengan daya 3 kWp akan mengurangi laju emisi gas rumah kaca sekitar 2,7 ton/tahun.*

**Kata kunci:** simulasi, data pengukuran, system PLTS atap, Surabaya

---

---

## I. INTRODUCTION

Solar electricity using a photovoltaic (PV) system is one of the most promising of renewable energies to substitute fossil fuels for power generation, particularly for Indonesia which is benefitting of its geographical position at the equator line. The Government of Indonesia has set a target of national energy demand that will be supplied fossil fuel and mix of 23% from renewables by the year 2025 [1]. Solar power

generation has a significant portion expected to fulfill the target. The policy of the PV rooftop system [2] has recently been introduced to encourage users, residents, and industries, to use a PV system for power generation.

Before the real installation of a rooftop PV system, the prediction should be made to estimate the cost and benefits in terms of the amount of energy generated. Simulation techniques using mathematical analysis with certain algorithms are commonly used for this purpose [3]-[7]. Ko, *et al*

(2015) [8] evaluated the potential of rooftop PV in Taiwan considering the shadow effect caused by building structures using the Hillshade module. Rachchh, *et al* (2016) [9] did a mathematical analysis to maximize the number of solar panels installed in a given area by optimizing several installation parameters. Redweik, *et al* (2013) [10] developed a solar 3D urban model to calculate the solar energy potential on the roof and facades of a building in urban areas.

Every geographical position has different potential and characteristics of solar energy. This study takes Surabaya area of position as the study object. This is considered important as the Indonesian government is now promoting solar rooftop. The discussion is not limited to the technical aspect, but also on economic, environmental, and development opportunities due to recent national policies.

The objective of this study is to compare the energy output between a simulation of a 3 kWp rooftop PV under the climate of Surabaya, Indonesia with real measurement data of a year. The comparison result along with studies on recent national policies will then give a feasibility study of the rooftop PV system implementation, especially in Surabaya, Indonesia. The simulations were done using SolarGIS PV Planner and RETScreen. SolarGIS PV Planner used to estimates energy output from the system, while RETScreen used to analyze the feasibility and environmental impact of implementing this system. The real measurement data were taken from a 3kWp rooftop PV that has been build before. The comparison result will give an estimation of the efficiency of the general rooftop PV system. The recent national policies discussed in this study are all government rules on energy, including national energy policies and several policies on the rooftop PV system, from the year 2014 until 2019. The results from this work are expected to help in demonstrating the advantages and challenges of installing a rooftop PV system in Surabaya, Indonesia.

## II. RESEARCH METHOD

As previously mentioned above that the present study compares the energy output between simulation results and real installation of a 3 kWp on-grid PV system. A full year of measurement results from the real installation is compared to the simulation results. The simulation is carried out using a combination of SolarGIS PV Planner [11]

and RETScreen [12] simulation tools. RETScreen is free and available online, and Solar GIS PV Planner is paid software and we have licensed. The SolarGIS PV Planner provides an online assessment on any selected site. The software applies numerical simulation from the climate databases. RETScreen software simulation provides analysis tools that enable feasibility analysis for the on-grid PV system, as well as various renewable energy systems. The availability of the solar insolation at a selected area is predicted by the software from the real measurement data of the nearest weather station.

### A. PV System Installation

The 3 kWp PV system consists of twenty-two modules with a capacity of 140 Wp for each module. The specification of the module is presented in Table 1. After converting the electricity output using a 3000 Watt DC-AC inverter, it is delivered to the building’s utility grid system through a panel distribution. The schematic diagram of the on-grid PV system is shown in Figure 1. The modules (array) are mounted on the roof of the Main Library Building, University of Surabaya. The photograph of the system as shown in Figure 2.

**Table 1. PV module specification**

Parameters	Value
Nominal maximum power [Pmax]	140 W
Optimum operating voltage [Vpm]	17.323 V
Optimum operating current [Ipm]	8.1 A
Open circuit voltage [Voc]	21.91 V
Short circuit current [Isc]	8.7 A
Maximum system voltage [Vmax]	1,000 V
Maximum series fuse rating	10 A

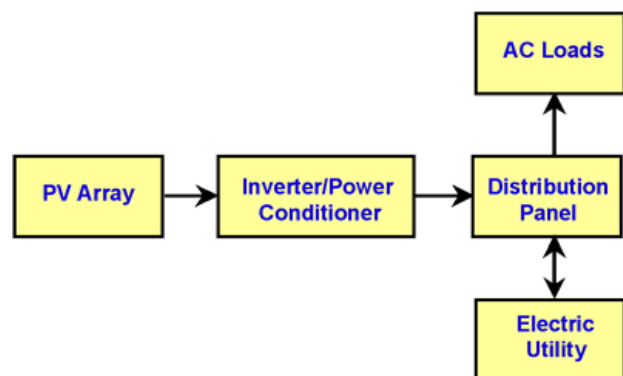

**Figure 1. On-grid installation system**



Figure 2. Photograph of the PV system showing solar panels (a) and on-grid inverter (b)

Figure 3 shows the input parameters for the SolarGIS PV Planner. The interface is divided into several sections:

- System Information:** PV system name: UBAYA; Installed power (kWp): 3; Installation type: roof mounted.
- Module Settings:** Module technology type: crystalline silicon (c-Si); Installation date: July of 2018.
- Mounting Settings:** Mounting type: one angle; Azimuth of modules (°): 135; Tilt of modules (°): 45. A diagram shows a solar panel tilted at an angle with labels for Azimuth and Tilt.
- Losses and Efficiency:** Inverter efficiency: 97.5; DC losses: total DC losses (5.4%); AC losses: total AC losses (1.5%).
- Shading:** Apply shading by horizon: yes; Horizon: Default.

Figure 3. Input parameters for SolarGIS PV Planner

### B. Simulation's Parameters

The input parameters for simulation were set as closed condition as possible with the real installation. For the module type, the crystalline silicon (c-Si) PV module was selected (the same type as the real module installed). The other parameters for SolarGIS simulation, such as the mounting type, installation type, azimuth of modules, tilt of modules, shading by the horizon, inverter efficiency, DC losses and total AC losses which were set as shown in Figure 3.

For feasibility analysis, including financial and emission analysis the RETScreen software was used. Table 2 shows the input parameters used in the RETScreen simulation. The value in the parameters is attempted to fit with the present condition.

Table 2. Simulation parameters for feasibility analysis

Parameters	Value
Inflation rate	5 %
Project life	20 yr
Debt ratio	50 %
Debt interest rate	6 %
Debt Term	10 yr
Capacity factor	14%
Electricity export rate	1.2 USD/kWh.
GHG emission factor	0.709 tCO <sub>2</sub> /MWh

### III. RESULT AND DISCUSSION

The measurement and monthly data recording were carried out for the PV system. The recording data presented here is from April 2018 to March 2019. The monthly output energy in kWh for each month is presented in Figure 4. It was found that the highest monthly energy output about 369 kWh, produced during October, and the minimum about 260 kWh during June. The daily energy output is

found varies from 7.50 – 16.0 kWh, with an average of 10.82 kWh. The annual energy output was about 3,898 kWh.

The significant low energy output during the period June to August (which was dry season period on the other hand) is predicted due to dust and particles covered the modules. The manual cleaning of the module was done once in the middle of July, and it resulted in significantly increasing energy output as shown in Figure 4. Further investigation on the effect of the energy production dust during the dry season is recommended. The peak of the rainy season during January – February might be the reason for low energy production.

The astronomical position of the simulated location is at 07° 19' 17.83" S and 112° 46' 3.19" E (University of Surabaya). The length of the day and the solar zenith angle is presented in Figure 5. The simulation results for the monthly global irradiation which is from direct, diffuse and reflected components are shown in Figure 6. The average daily sum of global irradiation on the horizontal surface is about 5.54 kWh/m<sup>2</sup> per day with the maximum value of 6.81 kWh/m<sup>2</sup> (September) and a minimum of 4.82 kWh/m<sup>2</sup> (December). The diffuse component of radiation is quite significant especially during March – October, while reflected radiation relatively small throughout the year.

The global radiation in the past time was usually higher during month April – October than the other months due to dry season, meanwhile low radiation during December – March due to rainy season. However, in the present time, the season period is

likely unpredictable, and further investigation should be done [5]. Daily air temperature showed that the ambient temperature in Surabaya varies about 26 – 30°C. The solar energy potential and characteristics as shown in Fig. 5 and Fig. 6 are used as the input parameters for the simulation.

Simulation results for energy output from the 3 kWp PV system monthly for the year 2018 and 2019 are shown in Figure 7 and Figure 8. The simulation results are consist of expected with best, low and high estimates as well as potentially achievable and long term average. The highest energy output was about 467 kWh produced during July. The lowest energy production was in December and January which is about 190 kWh. Total annual energy production from the system is found at about 4,200 kWh.

It is seen that there are different results on energy output between simulation and the real PV system as previously presented above. The monthly comparison between simulation and the real system is presented in Figure 9. It was found that for the periods of April – September, energy production by simulation was slightly higher than the real PV installation. For the rest of the period, on the other hand, the real system produced slightly higher than the simulation results. The difference in total annual energy production is about 302 kWh or about 7.2% different (comparing 3,898 kWh from the real installation and 4,200 kWh from simulation). There might be many factors causing the difference such as dust, shading, weather, etc. The particular investigation should be done for this case.

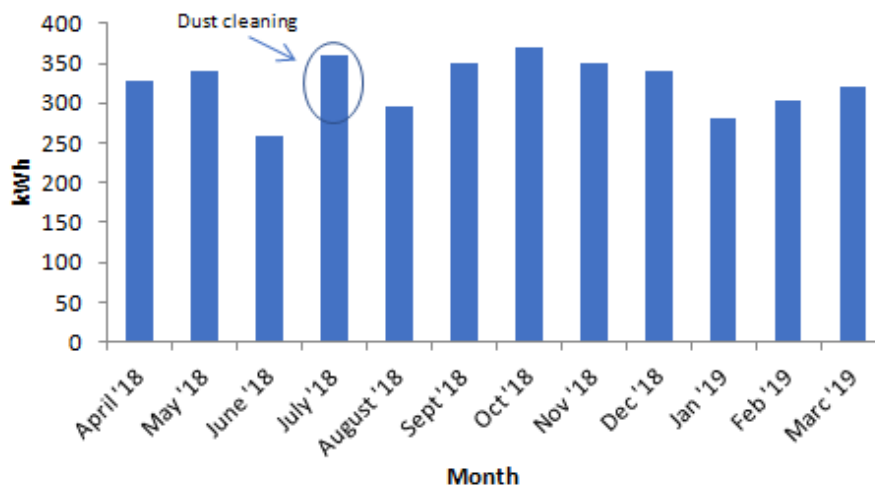

Figure 4. Energy production from a real installation PV system

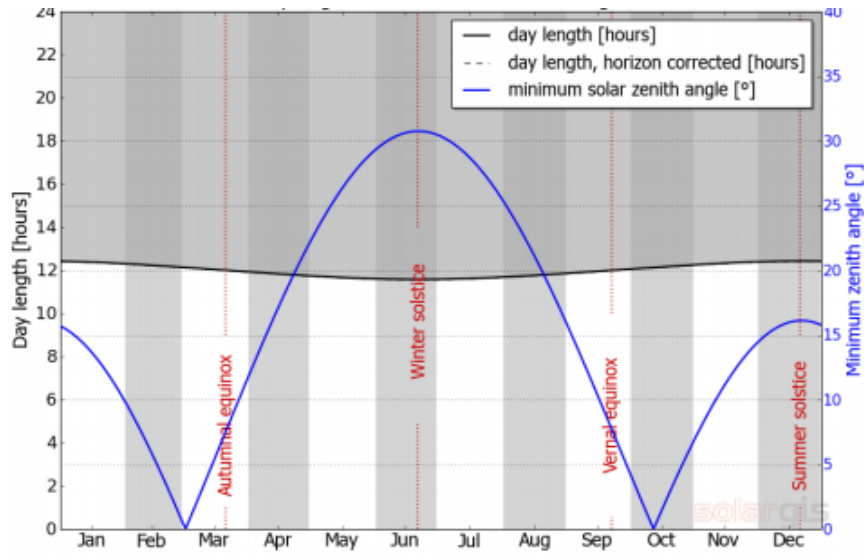

Figure 5. Day length and minimum solar zenith angle in Surabaya

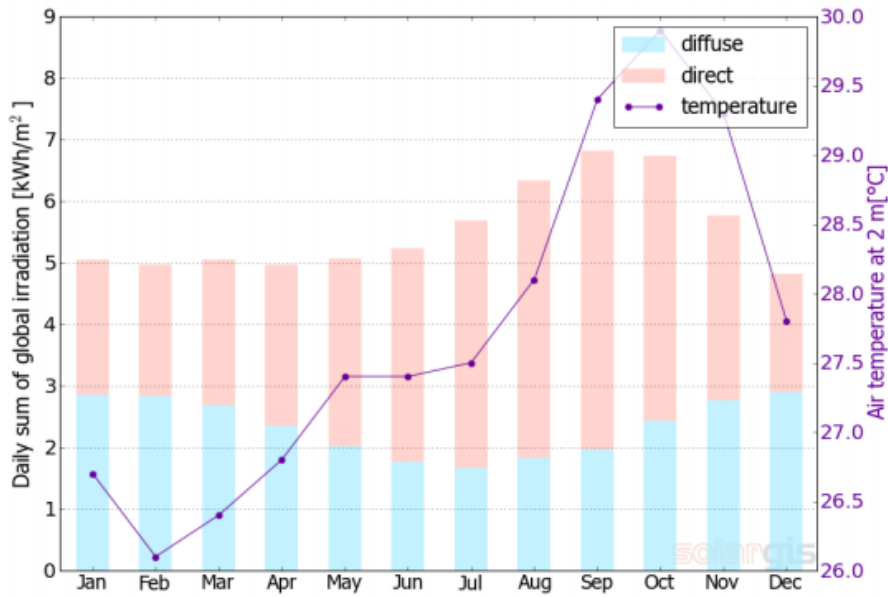

Figure 6. Global irradiation and air temperature in Surabaya

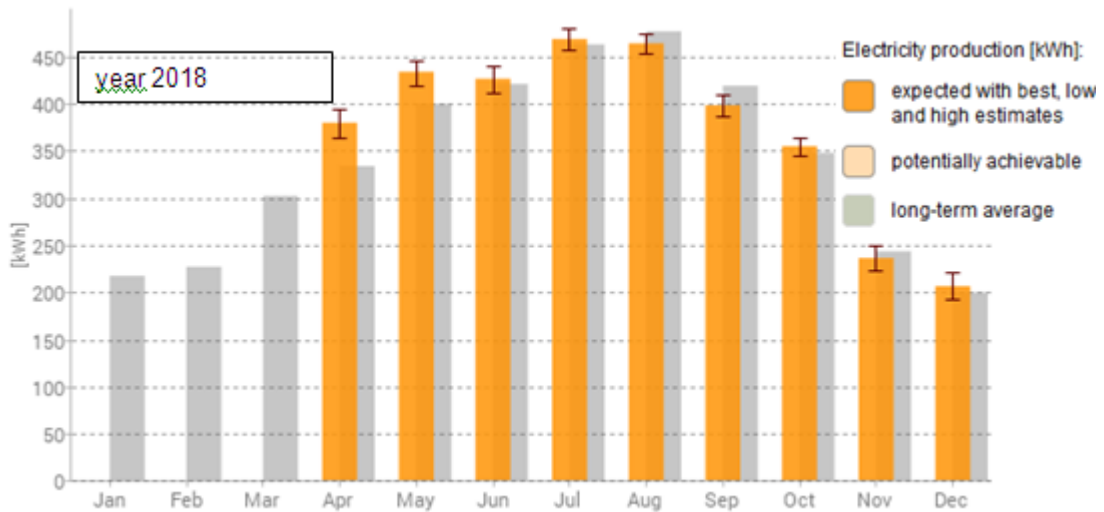

Figure 7. Monthly energy output from the PV system simulation for the year 2018

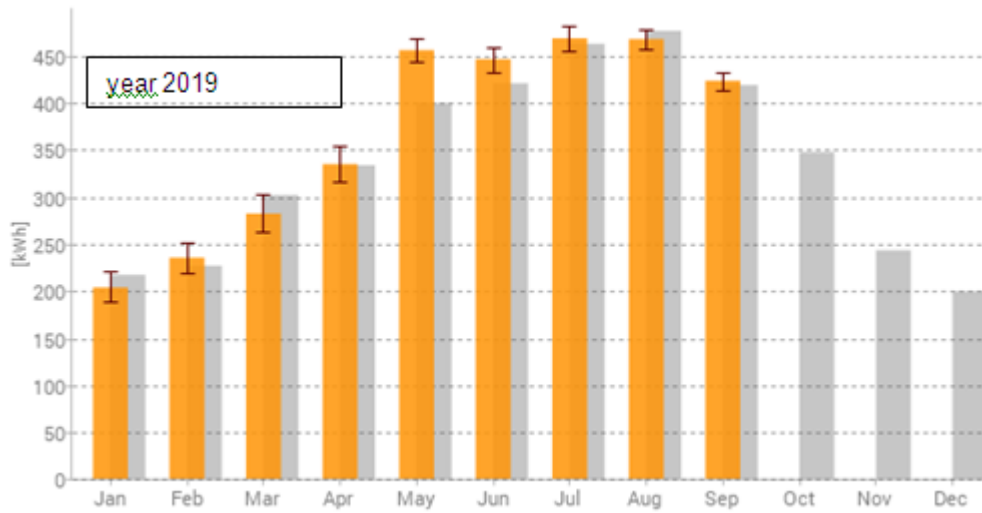

Figure 8. Monthly energy output from the PV system simulation for the year 2019

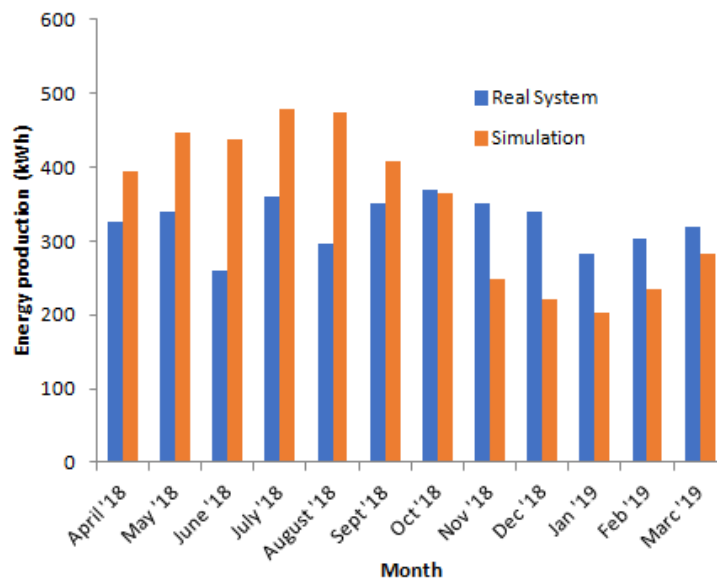

Figure 9. Comparison of energy output between simulation and the real installation system

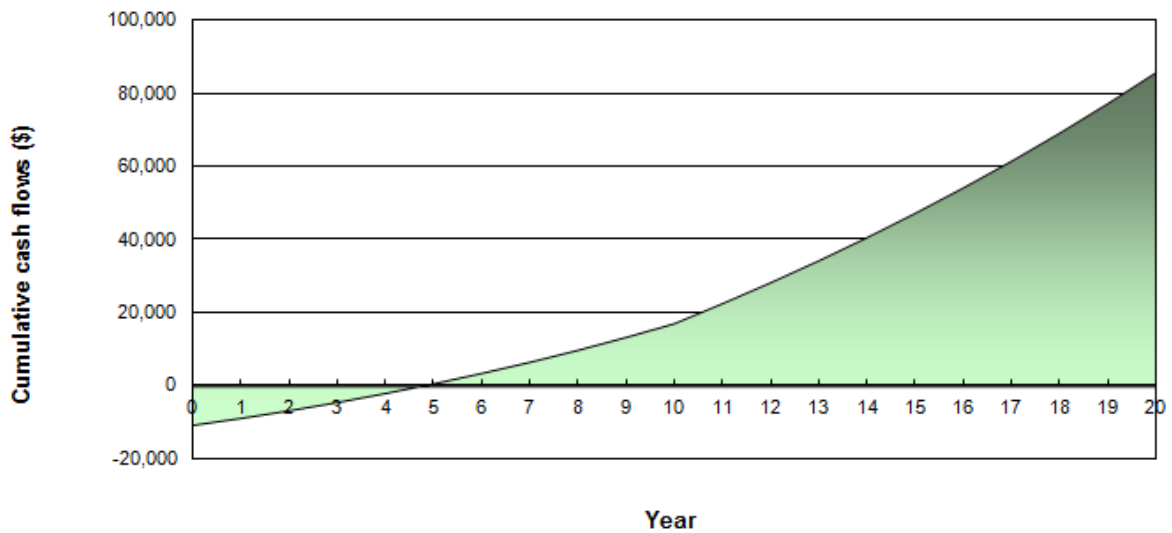

Figure 10. Cumulative cash flows of PV system investment

Table 3. t-Test result

Parameters	Real Data	Simulation Data
Mean	$3.24 \times 10^2$	$3.49 \times 10^2$
Variance	$1.13 \times 10^3$	$1.10 \times 10^3$
Observations	12.0	12.0
Pearson Correlation	$8.72 \times 10^{-2}$	
Hypothesized Mean Difference	0.000	
df	11.0	
t Stat	$-7.89 \times 10^{-1}$	
P (T <= t) one-tail	$2.23 \times 10^{-1}$	
t Critical one-tail	1.80	
P (T <= t) two-tail	$4.47 \times 10^{-1}$	
t Critical two-tail	2.20	

The similarity of both simulation results and the real data was tested using t-Test with the null hypothesis that those data are not significantly different. The t-Test result with  $\alpha = 5\%$  is  $-7.89 \times 10^{-1}$  (Table 3). It means that the calculation result failed to reject the null hypothesis or statistically, the real data and simulation results are similar. Thus the simulation tools can be used to estimate energy results for developing a bigger system.

Economic and environmental analysis using RETScreen under present time conditions shows that a grid-connected PV system investment would give about 5 years of the payback period. The annual cumulative cash flows are presented in Figure 10. The cumulative cash flow in the figure is from the accumulation of money value of electricity produced by the PV system in comparison to system incremental of installation cost. Environmentally, the 3 kWp PV system would give a reduction of CO<sub>2</sub> emission about 2.7 tons per year.

The government of Indonesia was recently issued a rooftop PV system policy [2] which allowing residences, industries, and organizations to export energy from a rooftop PV system to the utility grid (PLN). Considering the economic (payback period), the positive environmental impact, and the policy of the government, the grid-connected (on-grid) PV system would be a good option for electricity generation in Indonesia.

#### IV. CONCLUSION

There were slightly different results values of energy output between simulation and real measurement of the PV system, however statistically it still can be accepted. A longer period of measurement is recommended to validate the

results. Simulation and Experimental study of 3 kWp Rooftop PV System in Surabaya, Indonesia has been carried out. The annual energy production from the simulation was found about 4,200 kWh, while from the real measurement it was about 3,898, meaning that there is about 7.2% of different. A particular further investigation is recommended to do to find the reasons for the difference. Economic analysis shows that, under current conditions, a grid-connected PV system investment would give about 5 years of the payback period. Environmentally, the 3 kWp PV system would give a reduction of CO<sub>2</sub> emission about 2.7 tons per year.

#### REFERENCES

- [1] Government of Indonesia, *Peraturan Pemerintah No.79 Tahun 2014 Tentang Kebijakan Energi Nasional*. 2014.
- [2] Government of Indonesia, *Peraturan Menteri ESDM No. 49 Tahun 2018 tentang Penggunaan Sistem Pembangkit Listrik Tenaga Surya (PLTS) Atap*. 2018.
- [3] A. A. Merrouni and M. A. Moussaoui, "Integration of PV in the Moroccan Buildings: Simulation of a Small Roof System Installed in Eastern Morocco," vol. 6, no. 1, 2016.
- [4] J. Ordunez, E. Jadraque, J. Alegre, and G. Martinez, "Analysis of the photovoltaic solar energy capacity of residential rooftops in Andalusia (Spain)," *Renew. Sustain. Energy Rev.*, vol. 14, no. 7, pp. 2122–2130, 2010.
- [5] E. Tarigan, Djuwari, and F. D. Kartikasari, "Techno-economic Simulation of a Grid-connected PV System Design as Specifically Applied to Residential in Surabaya, Indonesia," in *Energy Procedia*, 2015, vol. 65, pp. 90–99.
- [6] E. Tarigan, "Simulation and Feasibility Studies of Rooftop PV System for University Campus Buildings in Surabaya, Indonesia," vol. 8, no. 2, 2018.
- [7] A. K. Shukla, K. Sudhakar, and P. Baradar, "Simulation and performance analysis of 110 kWp grid-connected photovoltaic system for residential building in India: A comparative analysis of various PV technology," *Energy Reports*, vol. 2, pp. 82–88, 2016.
- [8] L. Ko, J. C. Wang, C. Y. Chen, and H. Y. Tsai, "Evaluation of the development potential of rooftop solar photovoltaic in Taiwan," *Renew. Energy*, vol. 76, pp. 582–595, 2015.
- [9] R. Rachchh, M. Kumar, and B. Tripathi, "Solar photovoltaic system design optimization by shading analysis to maximize energy generation from limited urban area," *Energy Convers. Manag.*, vol. 115, pp. 244–252, 2016.
- [10] P. Redweik, C. Catita, and M. Brito, "Solar energy potential on roofs and facades in an urban landscape," *Sol. Energy*, vol. 97, pp. 332–341, 2013.

[11] Solargis.info, “SolarGIS PV Planner,” *SolarGIS*, 2014. [Online]. Available: <https://solargis.info/>.

[12] RETScreen, “Clean Energy Management Software,” 2019. [Online]. Available: <https://www.nrcan.gc.ca/energy/retscreen/7465>.